

Accessories - DDF10/8 (Flange)

Accessories - DD10F (Mounting Feet)

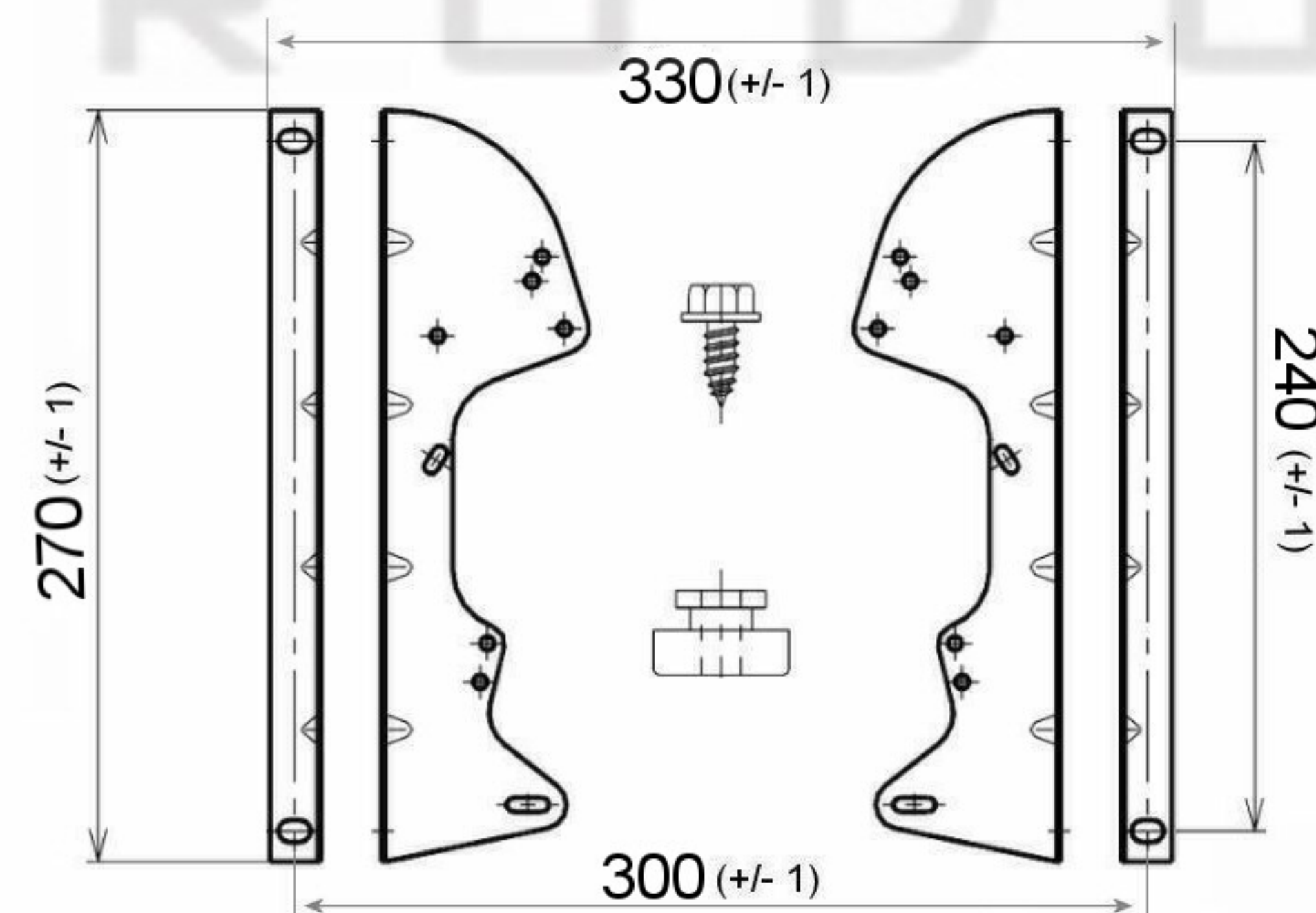

WIRING DETAILS

- | | | | |
|-------|--------------|---|------------------------------|
| MOTOR | Red | ● | A/C Live |
| | Black | ● | A/C Neutral |
| | Yellow/Green | ● | A/C Earth |
| | Red | ● | D/C 10v Out |
| | Black | ● | D/C Ground (-) |
| | Yellow | ● | D/C 0-10v In (speed control) |
| | Blue | ● | D/C Signal (Pulses - 12/rpm) |

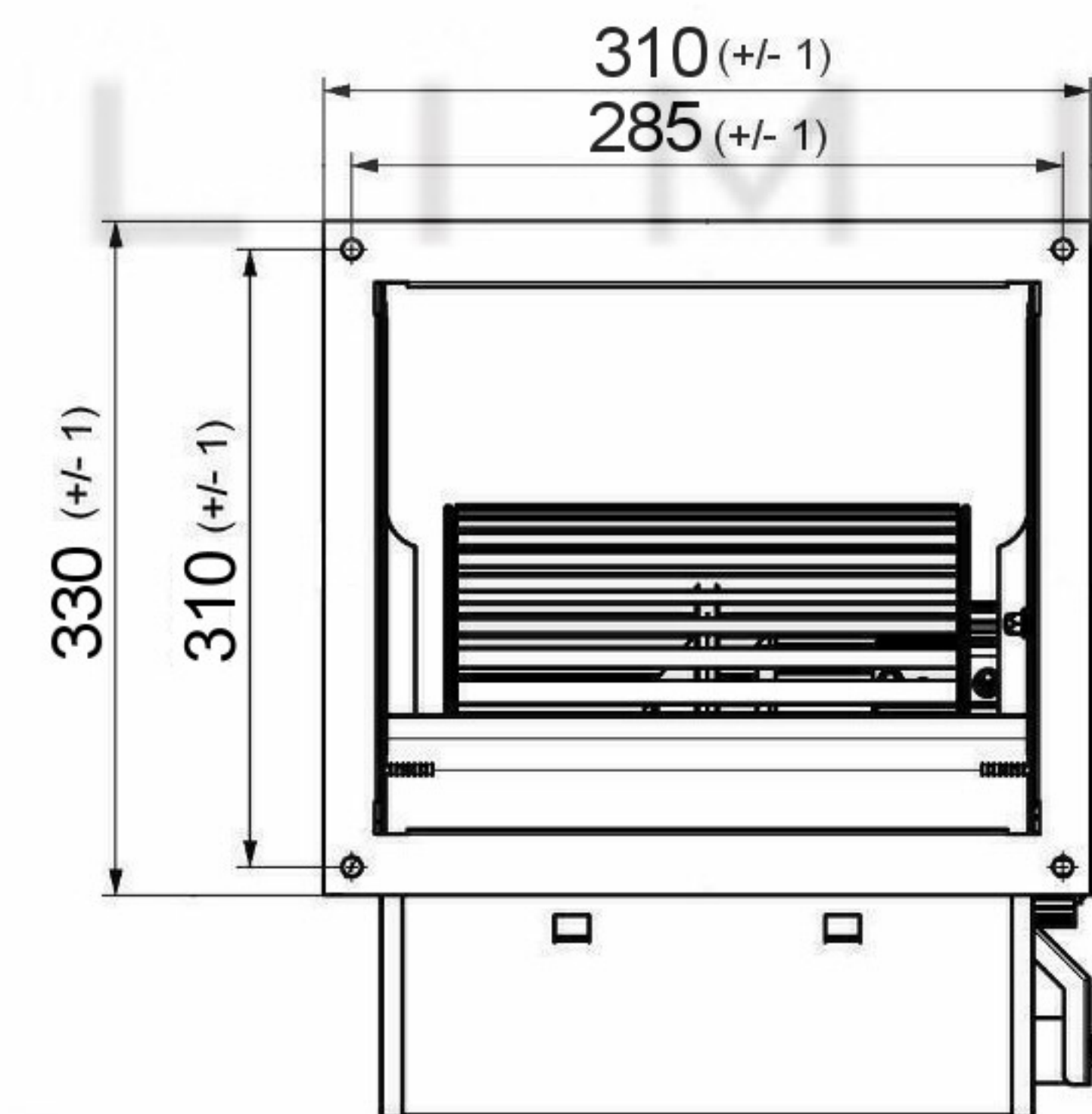

SPECIFICATION					
Motor	BLDC (EC)	Speed (RPM)	1250	Bearings	Ball
Voltage (V)	230/240	Motor Protection	Th.Prot	Weight (Kg)	
Frequency (Hz)	50/60	Insulation Class	B	Air Volume (M³/h)	
Power In/Out (W)	750	Protection Class	IP44	Noise Level (dBA)	
Current (A)	5.0			Pressure (Pa)	

POLE STAR
PRODUCTS LIMITED

POLE STAR PRODUCTS LIMITED	
Product Code DDEC1-10/8-750W-VSC	
Projection Angle ± 3°	
	A4 Scale: Sheet: 1 of