

B5 Flange



B14 Flange



B3 Flange

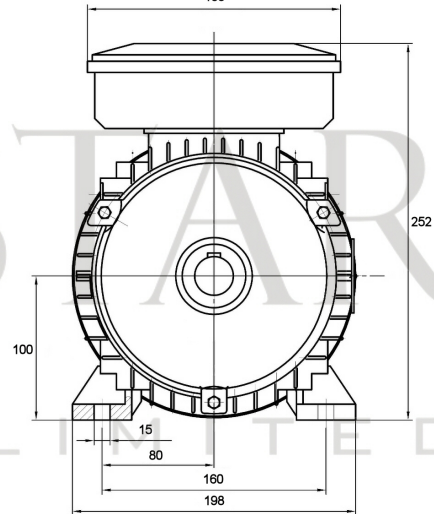
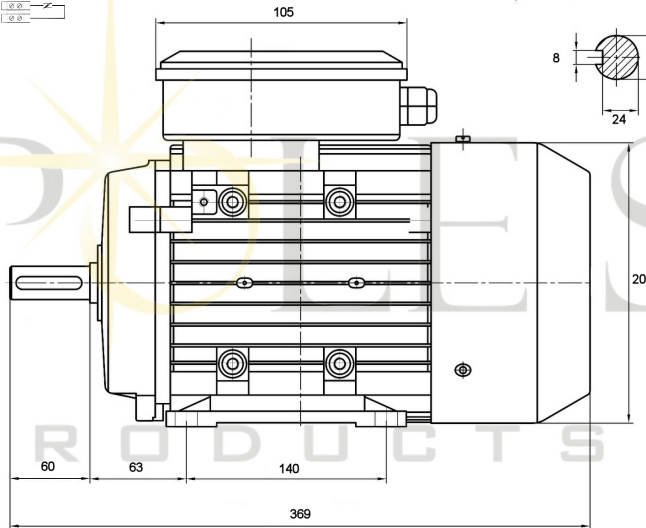

Unit of Measurement: mm

SPECIFICATION					
Motor	IE	Speed (RPM)	3000	Bearings	Ball
Voltage (V)	220 - 240 380 - 420	Motor Protection	Res. Prot.	ATEX Rated	No
Frequency (Hz)	50Hz	Insulation Class	F	Junction Box Material	Metal
Power In/Out (W)	3000	Protection Class	IP55	Material	Aluminium
Current (A)	12.5 - 13.8 7.1 - 7.9	Phase Type	Single	Cooling Type	Fan

POLE STAR
PRODUCTS LIMITED

POLE STAR PRODUCTS LIMITED	
Product Code	100L-TM3000S-B35
Projection Angle	± 3°
	A4
	Scale: 1 of 1
	Sheet: 1 of 1