

B5 Flange



B14 Flange



B3 Flange

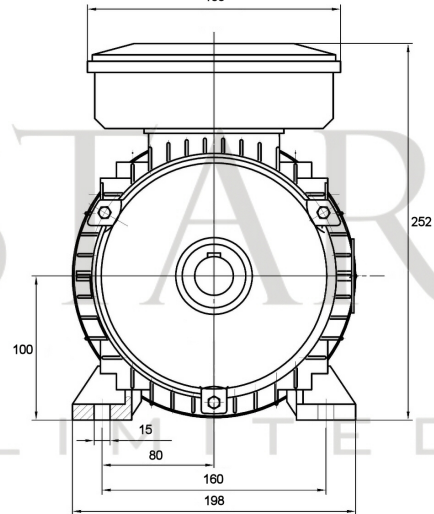
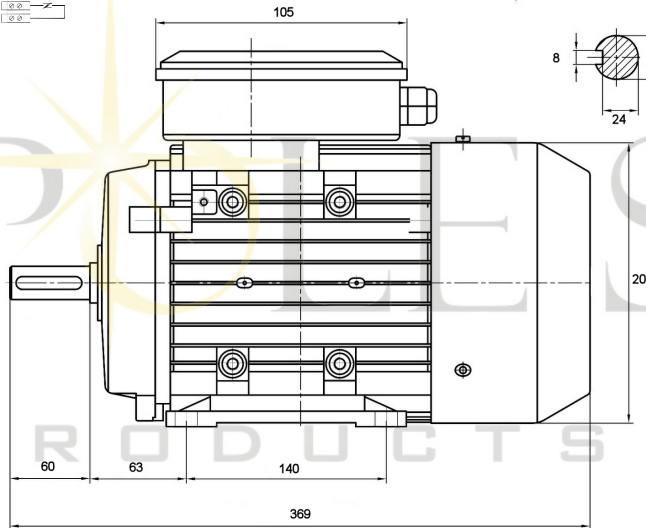

Unit of Measurement: mm

SPECIFICATION					
Motor	IE	Speed (RPM)	1500	Bearings	Ball
Voltage (V)	220 - 240 380 - 420	Motor Protection	Res. Prot.	ATEX Rated	No
Frequency (Hz)	50Hz	Insulation Class	F	Junction Box Material	Metal
Power In/Out (W)	2200W	Protection Class	IP55	Material	Aluminium
Current (A)	9.2 - 10.0 5.2 - 5.8	Phase Type	Single	Cooling Type	Fan

**POLE STAR**  
PRODUCTS LIMITED

POLE STAR PRODUCTS LIMITED

Product Code

**100L-FM2200S-B14**

Projection  
Angle

± 3°



A4

Scale:  
Sheet: 1 of